

PNP Germanium RF Transistor

AF 239 S

SIEMENS AKTIENGESELLSCHAFT

T-31-07

for output, mixer, and oscillator stages up to 900 MHz

AF 239 S is a germanium PNP mesa transistor in TO 72 case (18 A 4 DIN 41876). The leads are electrically insulated from the case.

Type	Ordering code
AF 239 S	Q62701-F51

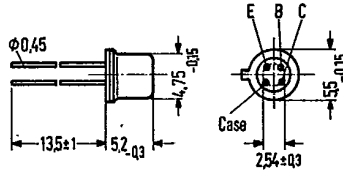

Approx. weight 0.4 g Dimensions in mm

Maximum ratings

Collector-emitter voltage	$-V_{CEO}$	15	V
Collector-emitter voltage	$-V_{CES}$	20	V
Emitter-base voltage	$-V_{EBO}$	0.3	V
Collector current	$-I_C$	10	mA
Emitter current	$I_E$	11	mA
Base current	$-I_B$	1	mA
Junction temperature	$T_j$	90	°C
Storage temperature range	$T_{stg}$	-30 to +75	°C
Total power dissipation ( $T_{amb} \leq 45^\circ\text{C}$ )	$P_{tot}$	60	mW

Thermal resistance

Junction to ambient air	$R_{thJA}$	$\leq 750$	K/W
Junction to case	$R_{thJC}$	$\leq 400$	K/W

**Static characteristics** ( $T_{amb} = 25^{\circ}\text{C}$ )

$-V_{CE}$ V	$I_C$ mA	$-I_B$ $\mu\text{A}$	$h_{FE}$ $I_C/I_B$	$-V_{BE}$ mV
10	2	40	50 (>10)	350
5	5	110	45	400

Collector cutoff current ( $-V_{CES} = 20\text{ V}$ )	$-I_{CES}$	0.5 (<8)	$\mu\text{A}$
Collector cutoff current ( $-V_{CEO} = 15\text{ V}$ )	$-I_{CEO}$	<500	$\mu\text{A}$
Emitter cutoff current ( $-V_{EBO} = 0.3\text{ V}$ )	$-I_{EBO}$	<100	$\mu\text{A}$

**Dynamic characteristics** ( $T_{amb} = 25^{\circ}\text{C}$ )

Transition frequency ( $-I_C = 2\text{ mA}$ ; $-V_{CE} = 10\text{ V}$ ; $f = 100\text{ MHz}$ )	$f_T$	780	MHz
Reverse transfer capacitance ( $-I_C = 2\text{ mA}$ ; $-V_{CE} = 10\text{ V}$ ; $f = 450\text{ kHz}$ )	$-C_{12e}$	0.2	pF

**Power gain**

Operating point:  $-I_C = 2\text{ mA}$ ;  $-V_{CE} = 10\text{ V}$

( $f = 800\text{ MHz}$ ; $R_L = 500\ \Omega$ )	$G_{pb}$	12.5	dB
( $f = 800\text{ MHz}$ ; $R_L = 2\text{ k}\Omega$ )	$G_{pb}$	15 (>12.5)	dB
( $f = 900\text{ MHz}$ ; $R_L = 500\ \Omega$ )	$G_{pb}$	12	dB
Noise figure ( $f = 800\text{ MHz}$ ; $R_g = 60\ \Omega$ )	NF	<5	dB
( $f = 900\text{ MHz}$ ; $R_g = 60\ \Omega$ )	NF	<6	dB

Test circuit for power gain and noise figure at  $f = 800\text{ MHz}$

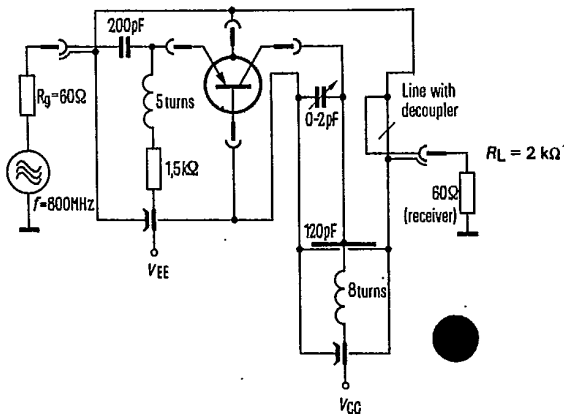

T-31-07

Total perm. power dissipation versus temperature  $P_{tot} = f(T)$ ;  $R_{th}$  = parameter

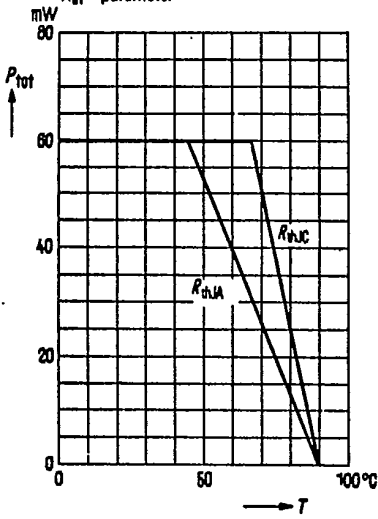

Collector cutoff current versus temperature  $I_{CBO} = f(T_{amb})$ ;  $-V_{CBO} = 20V$

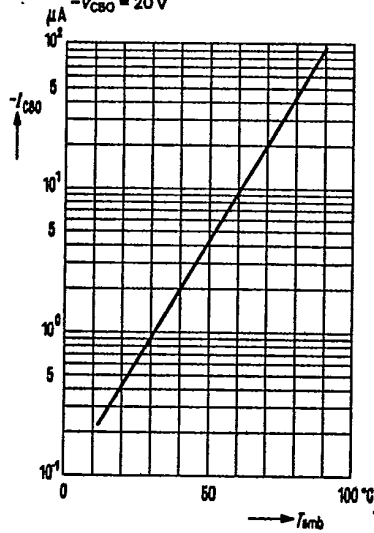

Collector current  $I_C = f(I_B)$ ;  $V_{CE}$  = parameter (common emitter configuration)

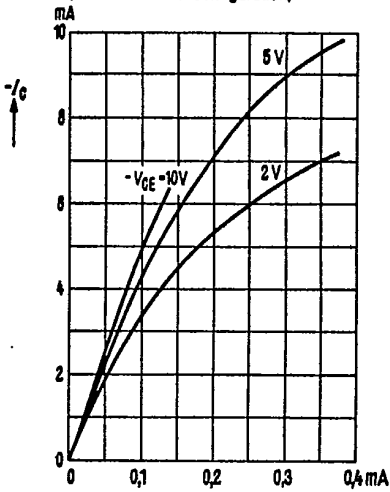

Collector current  $I_C = f(V_{BE})$ ;  $V_{CE}$  = parameter (common emitter configuration)

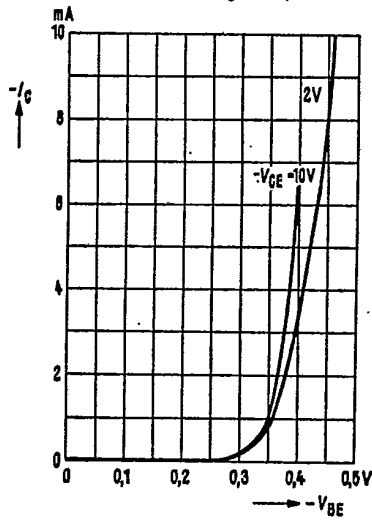

Output characteristics  $I_C = f(V_{CE})$   
 $I_B = \text{parameter}$   
 (common emitter configuration)

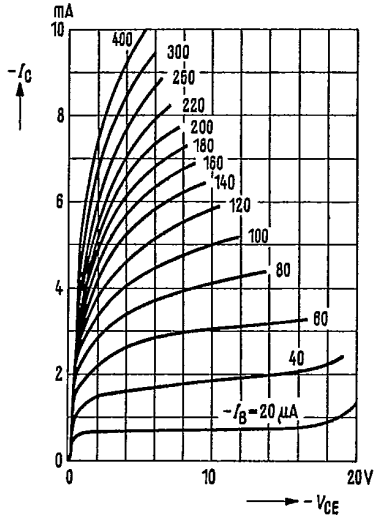

Output characteristics  $I_C = f(V_{CB})$   
 $I_E = \text{parameter}$   
 (common base configuration)

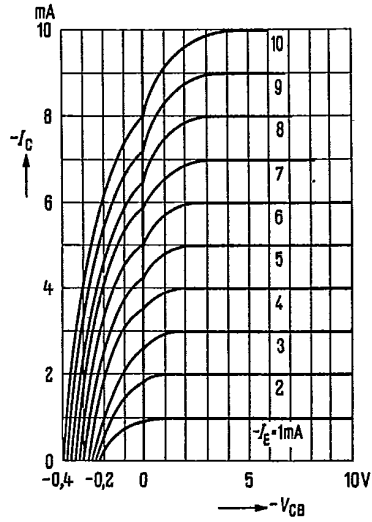

This datasheet has been download from:

[www.datasheetcatalog.com](http://www.datasheetcatalog.com)

Datasheets for electronics components.