

NPN-Silizium-Fototransistor Silicon NPN Phototransistor

BP 103



Wesentliche Merkmale

- Speziell geeignet für Anwendungen im Bereich von 420 nm bis 1130 nm
- Hohe Linearität
- TO-18, Bodenplatte, klares Epoxy-Gießharz, mit Basisanschluß

Anwendungen

- Computer-Blitzlichtgeräte
- Lichtschranken für Gleich- und Wechsellichtbetrieb
- Industrieelektronik
- „Messen/Steuern/Regeln“

Features

- Especially suitable for applications from 420 nm to 1130 nm
- High linearity
- TO-18, base plate, transparent epoxy resin lens, with base connection

Applications

- Computer-controlled flashes
- Photointerrupters
- Industrial electronics
- For control and drive circuits

Typ Type	Bestellnummer Ordering Code
BP 103	Q62702-P75
BP 103-3/4	Q62702-P3577

Grenzwerte
Maximum Ratings

Bezeichnung Parameter	Symbol Symbol	Wert Value	Einheit Unit
Betriebs- und Lagertemperatur Operating and storage temperature range	$T_{op}; T_{stg}$	- 40 ... + 80	°C
Löttemperatur bei Tauchlötung Lötstelle ≥ 2 mm vom Gehäuse, Lötzeit $t \leq 5$ s Dip soldering temperature, ≥ 2 mm distance from case bottom $t \leq 5$ s	T_S	260	°C
Löttemperatur bei Kolbenlötung Lötstelle ≥ 2 mm vom Gehäuse, Lötzeit $t \leq 3$ s Iron soldering temperature, ≥ 2 mm distance from case bottom $t \leq 3$ s	T_S	300	°C
Kollektor-Emitterspannung Collector-emitter voltage	V_{CE}	50	V
Kollektorstrom Collector current	I_C	100	mA
Kollektorspitzenstrom, $\tau < 10 \mu\text{s}$ Collector surge current	I_{CS}	200	mA
Emitter-Basisspannung Emitter-base voltage	V_{EB}	7	V
Verlustleistung, $T_A = 25 \text{ }^\circ\text{C}$ Total power dissipation	P_{tot}	150	mW
Wärmewiderstand Thermal resistance	R_{thJA}	500	K/W

Kennwerte ($T_A = 25\text{ °C}$, $\lambda = 950\text{ nm}$)

Characteristics

Bezeichnung Parameter	Symbol Symbol	Wert Value	Einheit Unit
Wellenlänge der max. Fotoempfindlichkeit Wavelength of max. sensitivity	$\lambda_{S\text{ max}}$	850	nm
Spektraler Bereich der Fotoempfindlichkeit $S = 10\%$ von S_{max} Spectral range of sensitivity $S = 10\%$ of S_{max}	λ	420 ... 1130	nm
Bestrahlungsempfindliche Fläche Radiant sensitive area	A	0.12	mm ²
Abmessungen der Chipfläche Dimensions of chip area	$L \times B$ $L \times W$	0.5×0.5	mm × mm
Abstand Chipoberfläche zu Gehäuseoberfläche Distance chip front to case surface	H	0.2 ... 0.8	mm
Halbwinkel Half angle	φ	± 55	Grad deg.
Fotostrom der Kollektor-Basis-Fotodiode Photocurrent of collector-base photodiode $E_e = 0.5\text{ mW/cm}^2$, $V_{CB} = 5\text{ V}$ $E_v = 1000\text{ lx}$, Normlicht/standard light a $V_{CB} = 5\text{ V}$	I_{PCB} I_{PCB}	0.9 2.7	μA μA
Kapazität Capacitance $V_{CE} = 0\text{ V}$, $f = 1\text{ MHz}$, $E = 0$ $V_{CB} = 0\text{ V}$, $f = 1\text{ MHz}$, $E = 0$ $V_{EB} = 0\text{ V}$, $f = 1\text{ MHz}$, $E = 0$	C_{CE} C_{CB} C_{EB}	8 11 19	pF pF pF
Dunkelstrom Dark current $V_{CE} = 35\text{ V}$, $E = 0$	I_{CEO}	5 (≤ 100)	nA

Die Fototransistoren werden nach ihrer Fotoempfindlichkeit gruppiert und mit arabischen Ziffern gekennzeichnet.

The phototransistors are grouped according to their spectral sensitivity and distinguished by arabian figures.

Bezeichnung Parameter	Symbol Symbol	Wert Value				Einheit Unit
		-2	-3	-4	-5	
Fotostrom, $\lambda = 950 \text{ nm}$ Photocurrent $E_e = 0.5 \text{ mW/cm}^2$, $V_{CE} = 5 \text{ V}$ $E_v = 1000 \text{ lx}$ Normlicht/standard light A $V_{CE} = 5 \text{ V}$	I_{PCE}	80 ... 160	125 ... 250	200 ... 400	≥ 320	μA
	I_{PCE}	0.38	0.6	0.95	1.4	mA
Anstiegszeit/Abfallzeit Rise and fall time $I_C = 1 \text{ mA}$, $V_{CC} = 5 \text{ V}$, $R_L = 1 \text{ k}\Omega$	t_r, t_f	5	7	9	12	μs
Kollektor-Emitter- Sättigungsspannung Collector-emitter saturation voltage $I_C = I_{PCEmin}^{1)} \times 0.3$ $E_e = 0.5 \text{ mW/cm}^2$	V_{CEsat}	150	150	150	150	mV
Stromverstärkung Current gain $E_e = 0.5 \text{ mW/cm}^2$, $V_{CE} = 5 \text{ V}$	$\frac{I_{PCE}}{I_{PCB}}$	140	210	340	530	–

¹⁾ I_{PCEmin} ist der minimale Fotostrom der jeweiligen Gruppe.

¹⁾ I_{PCEmin} is the min. photocurrent of the specified group.

Relative Spectral Sensitivity

$S_{rel} = f(\lambda)$

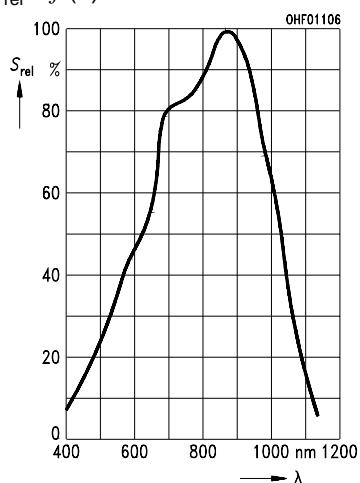

Photocurrent

$I_{PCE} = f(E_e), V_{CE} = 5 V$

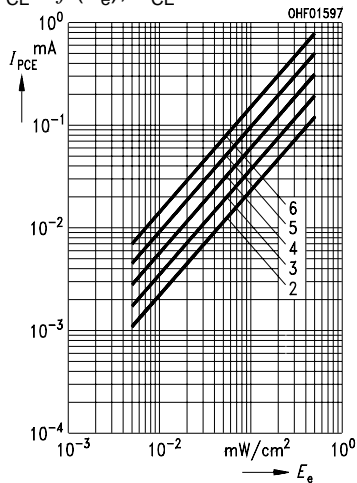

Total Power Dissipation

$P_{tot} = f(T_A)$

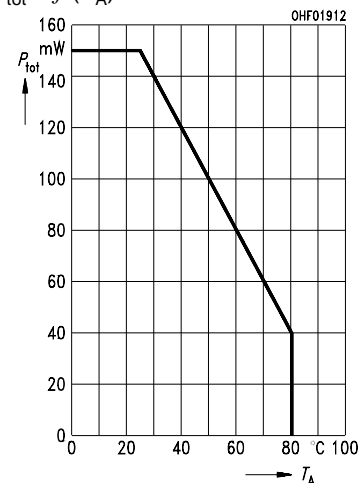

Output Characteristics

$I_C = f(V_{CE}), I_B = \text{Parameter}$

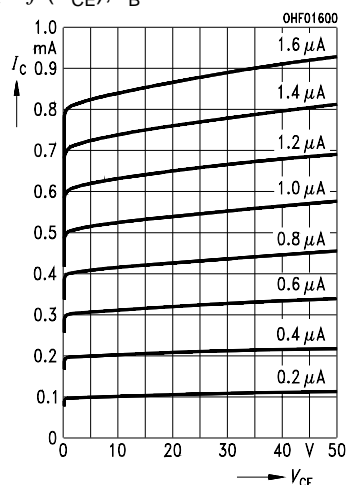

Output Characteristics

$I_C = f(V_{CE}), I_B = \text{Parameter}$

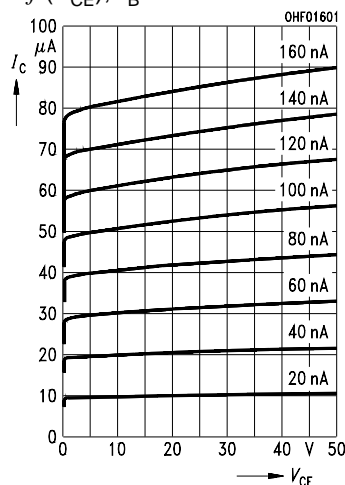

Dark Current

$I_{CEO} = f(V_{CE}), E = 0$

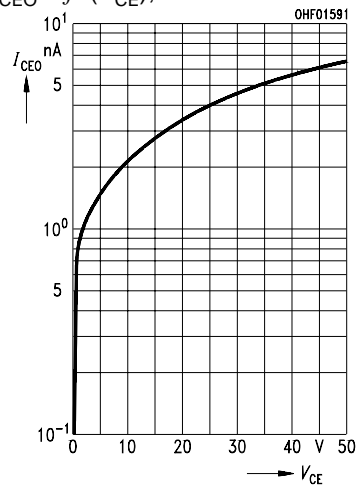

Photocurrent

$I_{PCE}/I_{PCE25^\circ} = f(T_A), V_{CE} = 5 V$

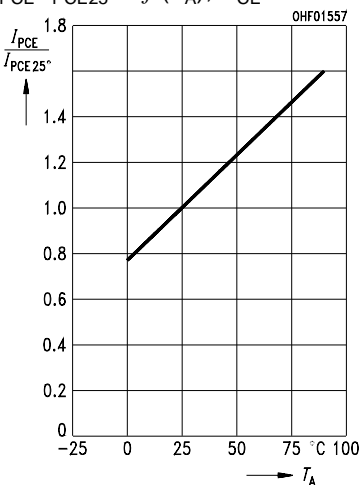

Dark Current $I_{CEO}/I_{CEO25^\circ} = f(T_A)$

$V_{CE} = 25 V, E = 0$

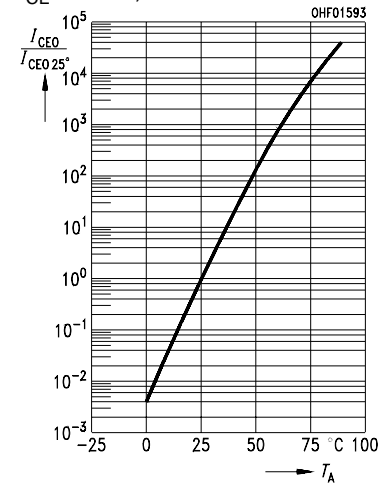

Collector-Emitter Capacitance

$C_{CE} = f(V_{CE}), f = 1 \text{ MHz}, E = 0$

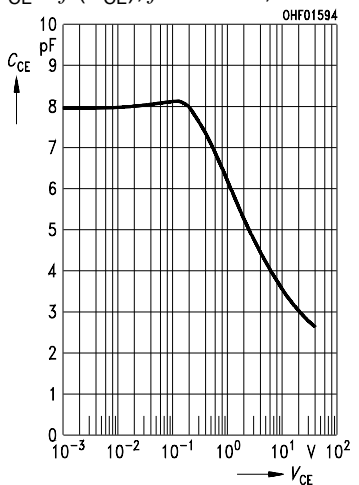

Collector-Emitter Capacitance

$C_{CB} = f(V_{CB}), f = 1 \text{ MHz}, E = 0$

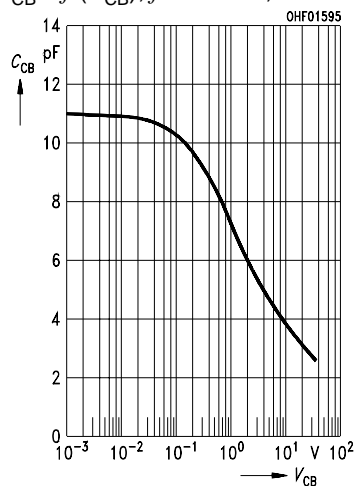

Emitter-Base Capacitance

$C_{EB} = f(V_{EB}), f = 1 \text{ MHz}, E = 0$

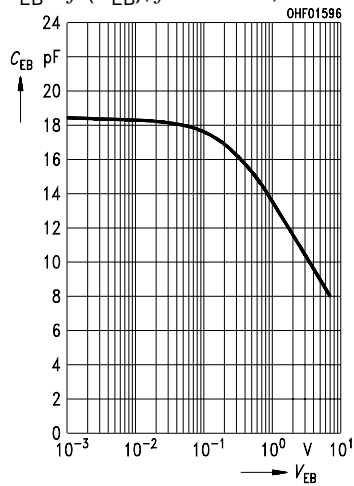

Directional Characteristics

$S_{rel} = f(\varphi)$

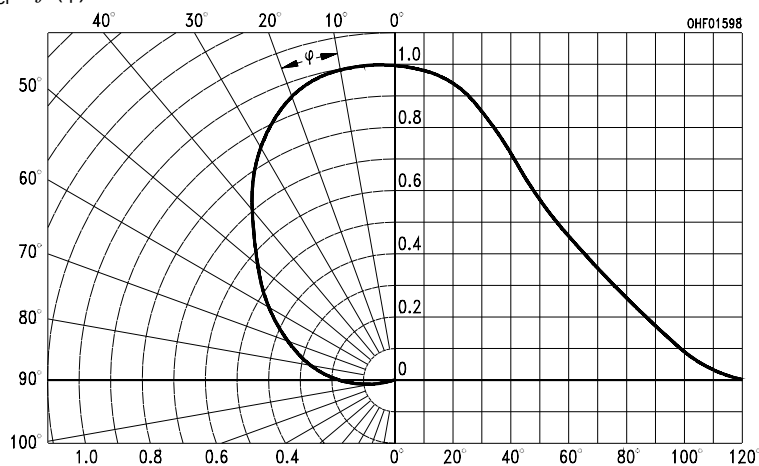

Maßzeichnung Package Outlines

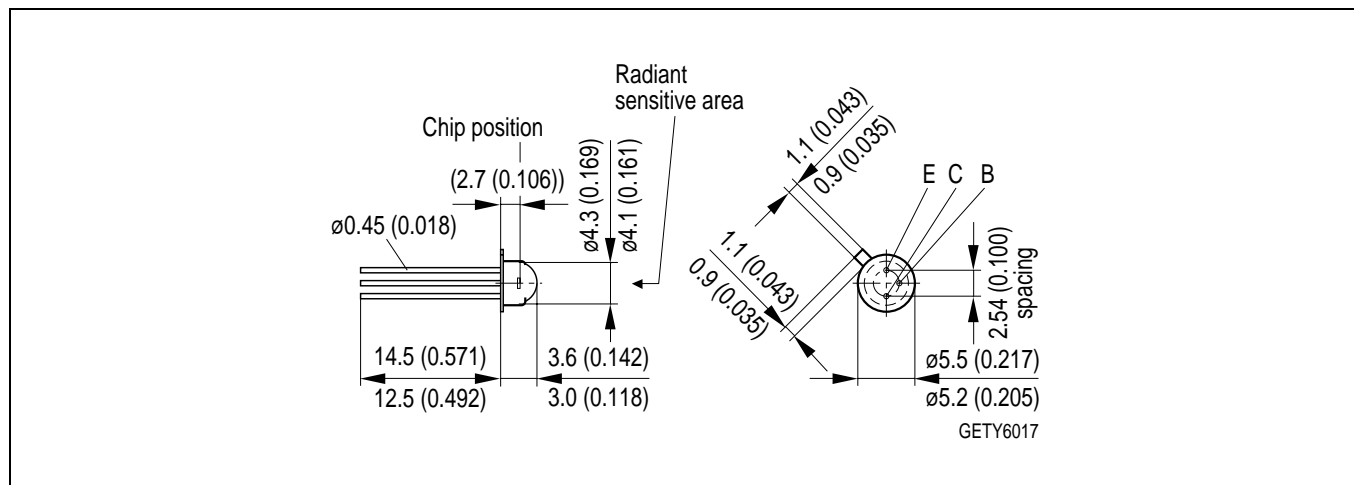

Maße werden wie folgt angegeben: mm (inch) / Dimensions are specified as follows: mm (inch).

Published by OSRAM Opto Semiconductors GmbH & Co. OHG
Wernerwerkstrasse 2, D-93049 Regensburg

© All Rights Reserved.

Attention please!

The information describes the type of component and shall not be considered as assured characteristics. Terms of delivery and rights to change design reserved. Due to technical requirements components may contain dangerous substances. For information on the types in question please contact our Sales Organization.

Packing

Please use the recycling operators known to you. We can also help you – get in touch with your nearest sales office. By agreement we will take packing material back, if it is sorted. You must bear the costs of transport. For packing material that is returned to us unsorted or which we are not obliged to accept, we shall have to invoice you for any costs incurred.

Components used in life-support devices or systems must be expressly authorized for such purpose! Critical components¹, may only be used in life-support devices or systems² with the express written approval of OSRAM OS.

¹ A critical component is a component used in a life-support device or system whose failure can reasonably be expected to cause the failure of that life-support device or system, or to affect its safety or effectiveness of that device or system.

² Life support devices or systems are intended (a) to be implanted in the human body, or (b) to support and/or maintain and sustain human life. If they fail, it is reasonable to assume that the health of the user may be endangered.