

COMPLETE TV SOUND CHANNEL

The TDA 1190 is a monolithic integrated circuit in a 12-lead quad in-line plastic package. It performs all the functions needed for the TV sound channel:

- IF limiter-amplifier
- Active low-pass filter
- FM detector
- DC volume control
- AF preamplifier
- AF output stage

The TDA 1190 can give an output power of 4.2W ($d = 10\%$) into a 16Ω load at $V_s = 24V$, or 1.5W ($d = 10\%$) into an 8Ω load at $V_s = 12V$. This performance, together with the FM-IF section characteristics of high sensitivity, high AM rejection and low distortion, enables the device to be used in almost every type of television receivers. The device has no irradiation problems, hence no external screening is needed.

ABSOLUTE MAXIMUM RATINGS

V_s	Supply voltage (pin 10)	28	V
V_i	Input signal voltage (pin 1)	1	V
I_o	Output peak current (non-repetitive)	2	A
I_o	Output peak current (repetitive)	1.5	A
P_{tot}	Power dissipation: at $T_{tab} = 90^\circ C$	5	W
	at $T_{amb} = 80^\circ C$ (free air)	1	W
T_{stg}, T_j	Storage and junction temperature	-40 to 150	$^\circ C$

ORDERING NUMBER: TDA 1190

MECHANICAL DATA

Dimensions in mm

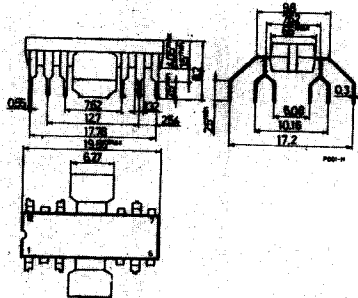

CONNECTION DIAGRAM (top view).

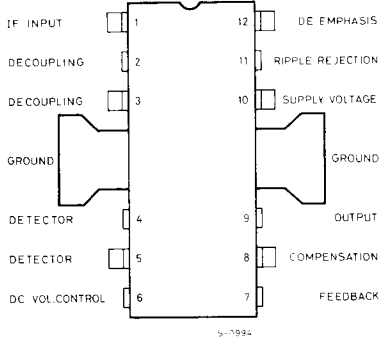

BLOCK DIAGRAM

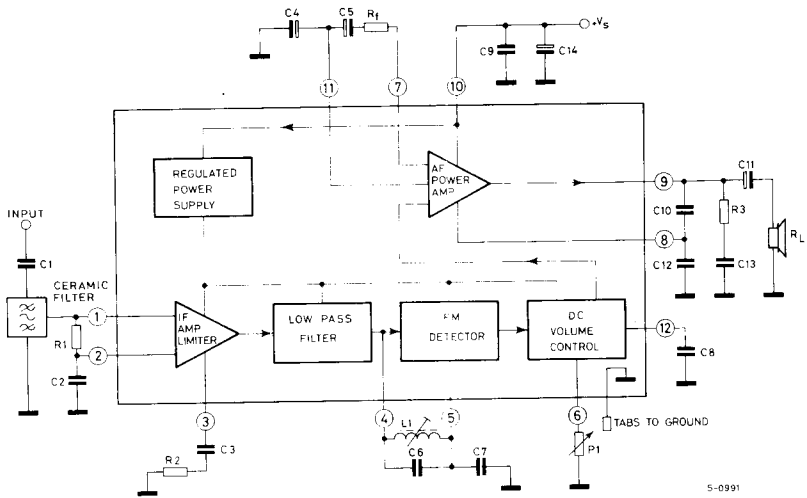

TEST CIRCUIT

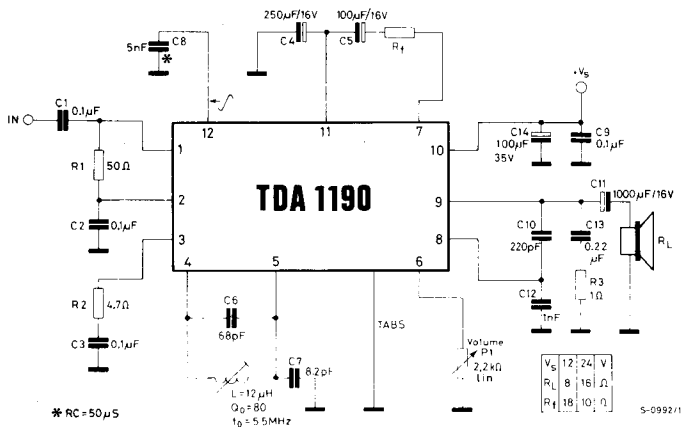

THERMAL DATA

$R_{th\ j-tab}$	Thermal resistance junction-tab	max	12	$^{\circ}C/W$
$R_{th\ j-amb}$	Thermal resistance junction-ambient	max	70*	$^{\circ}C/W$

* Obtained with tabs soldered to printed circuit with minimized copper area

ELECTRICAL CHARACTERISTICS

(Refer to the test circuit, $V_s = 24V$, $T_{amb} = 25^{\circ}C$ unless otherwise specified)

Parameter	Test conditions	Min.	Typ.	Max.	Unit
V_s	Supply voltage (pin 10)	9		28	V
V_o	Quiescent output voltage (pin 9)	$V_s = 24V$ 11 $V_s = 12V$ 5.5	12 6	13 6.5	V V
I_d	Quiescent drain current	$P_1 = 2.2\ k\Omega$ $V_s = 24V$ $V_s = 12V$	22 19	35 31	mA mA
P_o	Output power	$d = 10\%$ $f_0 = 5.5\ MHz$ $f_m = 1\ kHz$ $\Delta f = \pm 25\ kHz$ $V_s = 24V$ $V_s = 12V$	$R_L = 16\ \Omega$ 4.2 $R_L = 8\ \Omega$ 1.5		W W

TDA 1190

ELECTRICAL CHARACTERISTICS (continued)

Parameter	Test conditions	Min.	Typ.	Max.	Unit
P_o	Output power				
	$d = 2\%$ $f_o = 5.5 \text{ MHz}$ $f_m = 1 \text{ kHz}$ $\Delta f = \pm 25 \text{ kHz}$ $V_s = 24\text{V}$ $V_s = 12\text{V}$	$R_L = 16 \Omega$ $R_L = 8 \Omega$	3.4 1.35		W W
V_i	Input limiting voltage (-3 dB) at pin 1		30		μV
d	Distortion		0.55 0.65		% %
	$P_o = 50 \text{ mW}$ $f_o = 5.5 \text{ MHz}$ $f_m = 1 \text{ kHz}$ $\Delta f = \pm 7.5 \text{ kHz}$ $V_s = 24\text{V}$ $V_s = 12\text{V}$	$R_L = 16 \Omega$ $R_L = 8 \Omega$			
B	Frequency response of audio amplifier (-3 dB)		50 to 12,000 50 to 9,100		Hz Hz
	$R_L = 16 \Omega$ C10 = 220 pF C12 = 1000 pF P1 = 2.2 k Ω $R_f = 18 \Omega$ $R_f = 10 \Omega$				
V_o	Recovered audio voltage (pin 12)		60		mV
	$V_i \geq 1 \text{ mV}$ $f_o = 5.5 \text{ MHz}$ $f_m = 1 \text{ kHz}$ $\Delta f = \pm 7.5 \text{ kHz}$ P1 = 0				
AMR	Amplitude modulation rejection		55		dB
	$V_i \geq 1 \text{ mV}$ $f_o = 5.5 \text{ MHz}$ $f_m = 1 \text{ kHz}$ $\Delta f = \pm 50 \text{ kHz}$ $m = 0.3$				
$\frac{S+N}{N}$	Signal to noise ratio		70		dB
	$V_i \geq 10 \text{ mV}$ $f_o = 5.5 \text{ MHz}$ $V_o = 4\text{V}$ $f_m = 1 \text{ kHz}$ $\Delta f = \pm 50 \text{ MHz}$				
R_f	Internal feedback resistance (pins 7 and 9)	3.5	5	6.5	k Ω
R_i	Input resistance (pin 1)		30		K Ω
C_i	Input capacitance (pin 1)		5		pF
	$V_i = 1 \text{ mV}$ $f_o = 5.5 \text{ MHz}$				
SVR	Supply voltage rejection		46		dB
	$R_L = 16\Omega$ $f_{\text{ripple}} = 100 \text{ Hz}$ P1 = 2.2 k Ω				
A	DC volume control attenuation		90		dB
	P1 = 2.2 k Ω				

Fig. 1 – Relative audio output voltage and output noise vs. input signal.

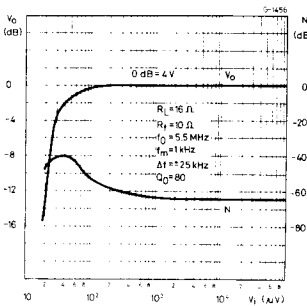

Fig. 2 – Output voltage attenuation vs. DC volume control resistance.

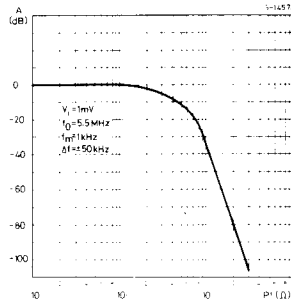

Fig. 3 – Amplitude modulation rejection vs. input signal.

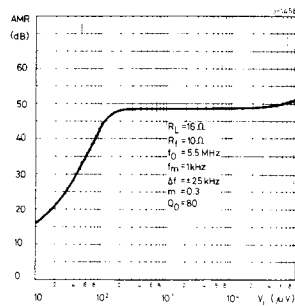

Fig. 4 – Δ AMR vs. tuning frequency change.

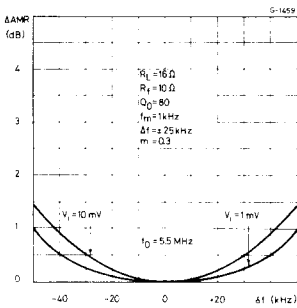

Fig. 5 – Recovered audio voltage vs. unloaded Q factor of the detector coil.

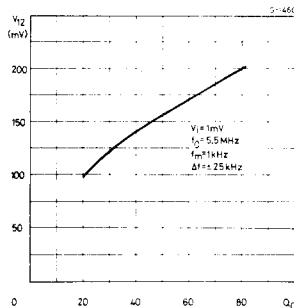

Fig. 6 – Distortion vs. output power.

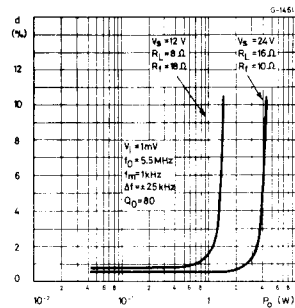

Fig. 7 – Distortion vs. frequency deviation.

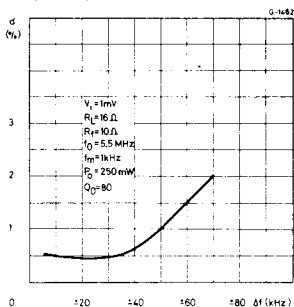

Fig. 8 – Distortion vs. tuning frequency change.

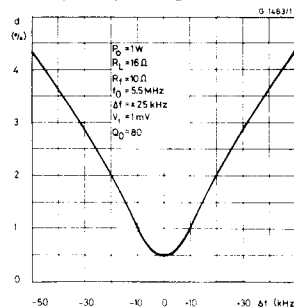
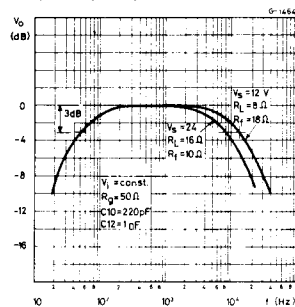

Fig. 9 – Audio amplifier frequency response.



TDA 1190

Fig. 10 - Supply voltage ripple rejection vs. ripple frequency

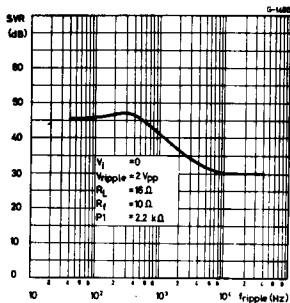

Fig. 11 - Supply voltage ripple rejection vs. volume control attenuation

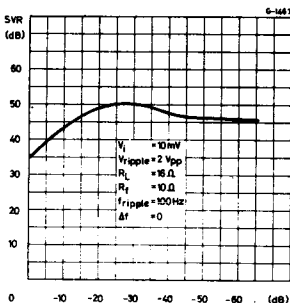

Fig. 12 - Output power vs. supply voltage

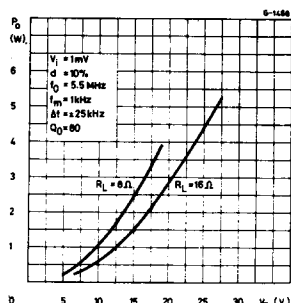

Fig. 13 - Maximum power dissipation vs. supply voltage (sine wave operation)

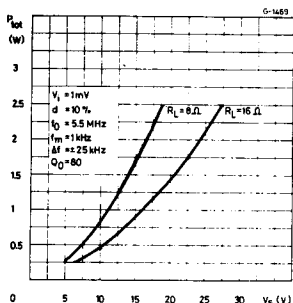

Fig. 14 - Power dissipation and efficiency vs. output power

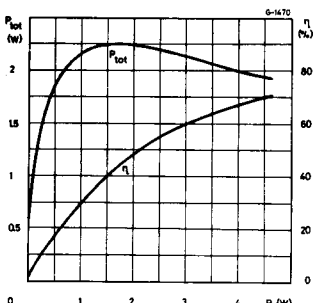
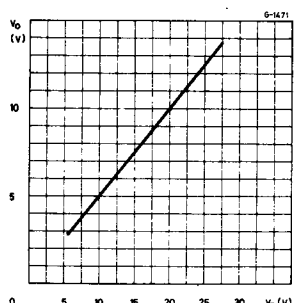

Fig. 15 - Quiescent output voltage (pin 9) vs. supply voltage



APPLICATION INFORMATION

The electrical characteristics of the TDA 1190 remain almost constant over the frequency range of 4.5 to 6 MHz, therefore it can be used in all television standards (FM mod.). The TDA 1190 has a high input impedance, so it can function with a ceramic filter or with a tuned circuit that provide the necessary input selectivity.

The value of the resistor connected to pin 7, determines the AC gain of the audio frequency amplifier. This enables the desired gain to be selected in relation to the frequency deviation at which the output stage of the AF amplifier must enter into clipping.

The capacitor connected between pins 9 and 8 determines the upper cut-off frequency of the audio band.

The capacitor connected between pin 12 and ground, together with the internal resistor of 10 kΩ, forms the de-emphasis network. The Boucherot cell eliminates the high frequency oscillations caused by the inductive load and the wires connecting the loudspeaker.

APPLICATION INFORMATION (continued)

Fig. 16 - Typical application circuit

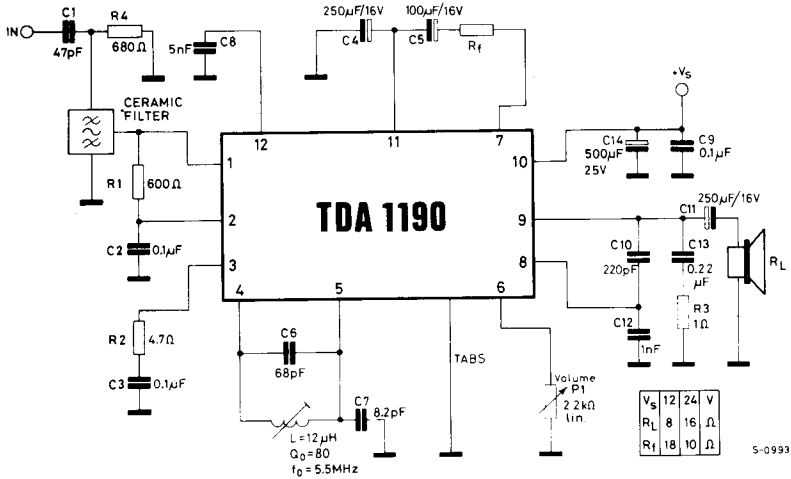
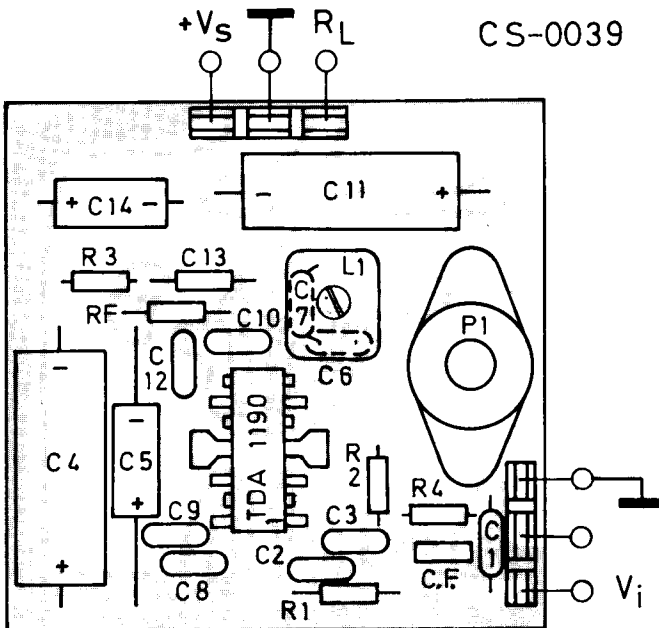

Fig. 17 - P.C. board and component layout of the circuit shown in fig. 16 (1:1 scale)



TDA 1190

MOUNTING INSTRUCTION

The $R_{th(j-amb)}$ of the TDA 1190 can be reduced by soldering the tabs to a suitable copper area of the printed circuit board (Fig. 18) or to an external heatsink (Fig. 19).

The diagram of figure 20 shows the maximum dissippable power P_{tot} and the $R_{th(j-amb)}$ as a function of the side "l" of two equal square copper areas having a thickness of $35\ \mu$ (1.4 mils).

During soldering the tab temperature must not exceed $260\ ^\circ\text{C}$ and the soldering time must not be longer than 12 seconds.

The external heatsink or printed circuit copper area must be connected to electrical ground.

Fig. 18 - Exampler of P.C. board copper area which is used as heatsink

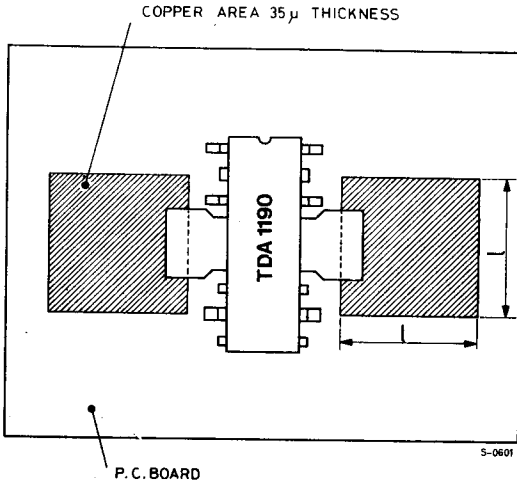

Fig. 19 - External heatsink mounting example

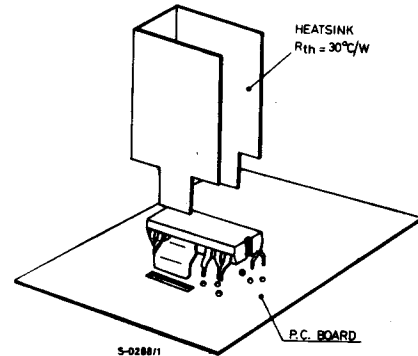

Fig. 20 - Maximum dissippable power and junction to ambient thermal resistance vs. side "l"

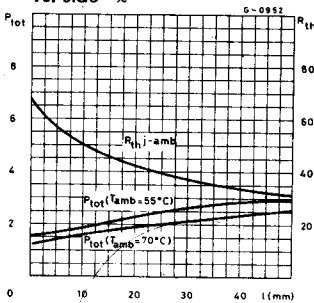

Fig. 21 - Maximum allowable power dissipation vs. ambient temperature

